



Features

- Meets or exceeds the requirements of ANSI Standard TIA/EIA-485-A and ISO 8482:1987(E) specifications for V_{CC} at $+5V \pm 5\%$
- Low quiescent current – 0.5mA typ., 1mA max.
- Low shutdown current (where applicable) - 0.01 μ A typical, 10 μ A max.
- Guaranteed standard data rate 250kbps or 10Mbps
- Thermal shutdown protection
- -7V to +12V common-mode input voltage range
- Half-Duplex or Full-Duplex configuration
- Allows up to 1/4 unit load (128 devices) on the same common bus
- Controlled driver output slew rate and receiver input filtering
- Active-high driver enable and active-low receiver enable
- ESD Protection on bus terminals ± 15 kV Human Body Model (HBM)
- Drop-in Replacements for MAX487E, MAX3291, MAX3292, SN75LBC182, SN65LBC182
- Standard fanout driving 1 unit load (32 devices) available on the ZT485E Series

General Description

The ZT485ER series devices are 5V differential data line transceivers for RS485/RS422 communication that consist of one driver and one receiver with high level of ESD protection. They are designed for balanced transmission lines interface that meet ANSI standard TIA/EIA-485-A and ISO 8482:1987(E) specifications.

The ZT485ER series devices spans out with half or full duplex, data rate guaranteed at 250k bit per second or 10Mbps, and allow one-fourth of an unit load that fan out 128 devices sharing a common bus. The I/Os are enhanced-electrostatic discharge (ESD) protected, exceeding ± 15 kV Human Body Model (HBM).

Applications

- RS422/RS485 communications
- Utility meters
- Industrial process control
- Building automation
- Level translators
- Transceivers for EMI-sensitive applications
- Routers and HUBs
- Industrial-controlled Local Area Networks
- Industrial PCs, embedded PCs and peripherals
- Industrial, security CATV and camera applications

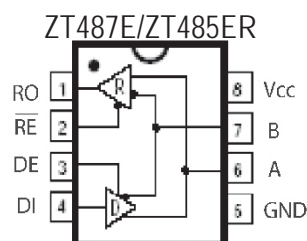

Product Selection Guide And Cross Reference

Part Number	Duplex	# Of Tx/Rx	Data Rate (Mbps)	# of Tx/Rx on Bus	Slew Rate Limit	Rx Input Filtering	Low-Power Shutdown	Tx/Rx Enable	ESD on Tx/Rx	Number of Pins	Pin-to-Pin Cross Reference
ZT485ER	Half	1/1	10	128	No	No	Yes	Yes	± 15 kV	8	n/a
ZT487E	Half	1/1	0.25	128	Yes	Yes	Yes	Yes	± 15 kV	8	SN75LBC182, MAX487E
ZT488ER	Full	1/1	0.25	128	Yes	Yes	No	No	± 15 kV	8	n/a
ZT489ER	Full	1/1	0.25	128	Yes	Yes	Yes	Yes	± 15 kV	14	n/a
ZT490ER	Full	1/1	10	128	No	No	No	No	± 15 kV	8	n/a
ZT491ER	Full	1/1	10	128	No	No	Yes	Yes	± 15 kV	14	MAX3291/92

Absolute Maximum Ratings

These are stress ratings only and functional operation of the device at these ratings or any other above those indicated in the operation sections of the specifications is not implied. Exposure to absolute maximum rating conditions for extended periods of time may affect reliability.

Power Supply, (V_{CC})..... -0.3V to +6.0V

Input Voltages

DI, DE, \overline{RE} (V_{IH}), High Input Voltage +2V to +6.0V

DI, DE, \overline{RE} (V_{IL}), Low Input Voltage 0V to +0.8V

Differential Input Voltage, (V_{ID}) -12V to +12V

A, B (V_I) +12V to -7V

Output Voltages

RO -0.3V to ($V_{CC} + 0.3V$)

Y, Z (A & B on ZT485)..... +12V to -7V

Operating Temperature..... -40°C to +85°C

Storage Temperature..... -65°C to +150°C

Power Dissipation Per Package

8-pin PDIP (derate 9.09mW/°C above +70°C) 722mW

8-pin nSOIC (derate 6.14mW/°C above +70°C)... 500mW

14-pin PDIP (derate 10.00mW/°C above +70°C) .. 800mW

14-pin nSOIC (derate 8.33mW/°C above +70°C). 667mW

Storage Considerations

Storage in a low humidity environment is preferred. Large high density plastic packages are moisture sensitive and should be stored in Dry Vapor Barrier Bags. Prior to usage, the parts should remain bagged and stored below 40°C and 60%RH. If the parts are removed from the bag, they should be used within 168 hours or stored in an environment at or below 20%RH. If the above conditions cannot be followed, the parts should be baked for 12 hours at 125°C in order to remove moisture prior to soldering. Zywyn ships product in Dry Vapor Barrier Bags with a humidity indicator card and desiccant pack. The humidity indicator should be below 30%RH. The MSL of this product is 3.

The information furnished by Zywyn has been carefully reviewed for accuracy and reliability. Its application or use, however, is solely the responsibility of the user. No responsibility of the use of this information become part of the terms and conditions of any subsequent sales agreement with Zywyn. Specifications are subject to change without the responsibility for any infringement of patents or other rights of third parties which may result from its use. No license or proprietary rights are granted by implication or otherwise under any patent or patent rights of Zywyn Corporation.

DC Electrical Characteristics

Unless otherwise stated, $V_{CC} = +5.0V$, $T_A = T_{min}$ to T_{max} , typical values apply at $V_{CC} = +5.0V$ and $T_A = 25^\circ C$.

Parameter	Condition	Min	Typ	Max	Units
TTL Logic Input TTL Logic Output RS485 Input RS485 Output Power Pin	DE, DI, \overline{RE} RO A, B Y, Z V_{CC} , V_{GND}	High $Z_{O/P}$ when disabled High $Z_{O/P}$ when disabled			
Temp 0°C to +70°C Temp -40°C to +85°C V_{CC} Voltage Range	Commercial Grade Industrial Grade $V_{CC} = +5.0V$ Supply	0 -40 4.75	+25 +25 5.0	+70 +85 5.25	°C °C V
Supply Current I_{CC} , Tx and Rx active I_{CC} , Tx active I_{CC} , Rx active I_{SD} , Shutdown Current	$DI=V_{CC}/GND$, $DE=V_{CC}$, $\overline{RE}=GND$, RS485 I/P=Open $DI=V_{CC}/GND$, $DE=V_{CC}$, $\overline{RE}=V_{CC}$, RS485 I/P=Open $DI=V_{CC}/GND$, $DE=GND$, $\overline{RE}=GND$, RS485 I/P=Open $DI=V_{CC}/GND$, $DE = GND$, $\overline{RE} = V_{CC}$, RS485 I/P=Open		400 400 400 1.0	900 900 900 10	μA μA μA μA
TTL LOGIC Input Input Threshold Low Input Threshold High	$V_{CC} = +5.0V$ Supply, DE, DI, and \overline{RE} $V_{CC} = +5.0V$ Supply, DE, DI, and \overline{RE}	2.0		0.8	V V
TTL LOGIC Output Output Voltage Low Output Voltage High Output Leakage Current Short Circuit Current	$I_{OUT} = +4mA$, Input Differential Voltage = 200mV $I_{OUT} = -4mA$, Input Differential Voltage = 200mV Receiver Outputs Disabled, $V_{OUT} = 0.4V$ to 2.4V $V_{OUT} = 0V$ to V_{CC}	3.5 7		0.4 ± 1 95	V V μA mA
Receiver Input Input Current Differential Threshold Voltage, V_{TH} Input Hysteresis Input Resistance, R_{IN}	$DE = 0V$, $V_{CC} = 0V$ to 5.25V, $V_{IN} = +12V$ $DE = 0V$, $V_{CC} = 0V$ to 5.25V, $V_{IN} = -7V$ $V_{CM} = 0V$, $V_{CC}=+5.0V$, $T_A=25^\circ C$ $V_{CM} = 0V$ $V_{CM} = -7V$ to +12V	-0.2 48	20	1.0 -0.8 +0.2	mA mA V mV k Ω
Transmitter Output Differential Output Voltage, V_{OD} Differential Output Voltage, dV_{OD} Driver Common Mode Output Change in Voltage Magnitude for Complimentary States, dV_{OC} Change in Voltage Magnitude for Complimentary States, V_{OC} Transmitter Short-Circuit Current	No Load With $R_L = 50\Omega$, $C_L = 50pF$, Refers to figure 1. (RS422) With $R_L = 27\Omega$, $C_L = 50pF$, Refers to figure 1. (RS485) With $R_L = 27\Omega$ or 50Ω . $C_L = 50pF$. Refers to figure 3. Differential Output Voltage, with $R_L = 27\Omega$ or 50Ω , $C_L = 50pF$. Refers to figure 1. Common-Mode Output Voltage, with $R_L = 60\Omega, 375\Omega, 375\Omega$. Refers to figure 2. Output HIGH, $V_{OUT} = -7V$ to +12V. Refers to figure 7. Output LOW, $V_{OUT} = -7V$ to +12V. Refers to figure 7.	2 1.5		5 5 3 0.2 0.2 250 250	V V V V V mA mA

AC Electrical Characteristics (ZT485ER, ZT490ER, and ZT491ER)

Unless otherwise stated, $V_{CC} = +5.0V$, $T_A = T_{min}$ to T_{max} , typical values apply at $V_{CC} = +5.0V$ and $T_A = 25^\circ C$.

Parameter	Condition	Min	Typ	Max	Units
Transmitter Timing					
Transmitter Propagation t_{PLH}	$R_{DIFF} = 54\Omega$, $C_L = 50pF$. Refers to figure 4.		35	60	ns
Transmitter Propagation t_{PHL}	$R_{DIFF} = 54\Omega$, $C_L = 50pF$. Refers to figure 4.		35	60	ns
Transmitter Output Skew t_{SK}	$ t_{PLH} - t_{PHL} $		3	10	ns
Transmitter Rise/Fall Time	t_r, t_f , $R_{DIFF} = 54\Omega$, $C_L = 50pF$, ZT485ER. Refers to figure 4.		15	25	ns
	t_r, t_f , $R_{DIFF} = 54\Omega$, $C_L = 50pF$, ZT490ER and ZT491ER, fig.4.		15	25	ns
Transmitter Output Enable	To Output HIGH, $C_L = 50pF$, $R_L = 110\Omega$. Refers to figure 5.		50		ns
	To Output LOW, $C_L = 50pF$, $R_L = 110\Omega$. Refers to figure 6.		50		ns
Transmitter Output Disable	From Output HIGH, $C_L = 50pF$, $R_L = 110\Omega$. Refers to figure 5.		50		ns
	From Output LOW, $C_L = 50pF$, $R_L = 110\Omega$. Refers to figure 6.		50		ns
Receiver Timing					
Receiver Propagation t_{PLH}	$C_L = 15pF$, Refers to figure 9.		50	150	ns
Receiver Propagation t_{PHL}	$C_L = 15pF$, Refers to figure 9.		50	150	ns
Differential Receiver Skew t_{SK}	$ t_{PHL} - t_{PLH} $		10		ns
Receiver Output Enable	To Output HIGH, $C_L = 15pF$. Refers to figure 10.		50		ns
	To Output LOW, $C_L = 15pF$. Refers to figure 11.		50		ns
Receiver Output Disable	From Output HIGH, $C_L = 15pF$. Refers to figure 10.		50		ns
	From Output LOW, $C_L = 15pF$. Refers to figure 11.		50		ns
Transceiver Throughput					
Maximum Data Rate	$R_L = 54\Omega$, $C_L = 50pF$, $T_A = 25^\circ C$	10			Mbps
ESD Tolerance					
ESD HBM	RS485 Inputs and Outputs		± 15		kV

AC Electrical Characteristics (ZT487E, ZT488ER, and ZT489ER)

Unless otherwise stated, $V_{CC} = +5.0V$, $T_A = T_{min}$ to T_{max} , typical values apply at $V_{CC} = +5.0V$ and $T_A = 25^\circ C$.

Parameter	Condition	Min	Typ	Max	Units
Transmitter Timing					
Transmitter Propagation t_{PLH}	$R_{DIFF} = 54\Omega$, $C_L = 50pF$. Refers to figure 4.	250	800	2000	ns
Transmitter Propagation t_{PHL}	$R_{DIFF} = 54\Omega$, $C_L = 50pF$. Refers to figure 4.	250	800	2000	ns
Transmitter Output Skew t_{SK}	$ t_{PLH} - t_{PHL} $		20	800	ns
Transmitter Rise/Fall Time	t_r , t_f , $R_{DIFF} = 54\Omega$, $C_L = 50pF$, Refers to figure 4.	250		2000	ns
Transmitter Output Enable	To Output HIGH, $C_L = 50pF$, $R_L = 110\Omega$. Refers to figure 5. To Output LOW, $C_L = 50pF$, $R_L = 110\Omega$. Refers to figure 6.		100		ns
Transmitter Output Disable	From Output HIGH, $C_L = 15pF$, $R_L = 110\Omega$. Refers to figure 5. From Output LOW, $C_L = 15pF$, $R_L = 110\Omega$. Refers to figure 6.		100		ns
			100		ns
Receiver Timing					
Receiver Propagation t_{PLH}	$C_L = 15pF$, Refers to figure 9.	250		2000	ns
Receiver Propagation t_{PHL}	$C_L = 15pF$, Refers to figure 9.	250		2000	ns
Differential Receiver Skew t_{SK}	$ t_{PHL} - t_{PLH} $		10		ns
Receiver Output Enable	To Output HIGH, $C_L = 15pF$, Refers to figure 10. To Output LOW, $C_L = 15pF$, Refers to figure 11.		100		ns
Receiver Output Disable	From Output HIGH, $C_L = 15pF$, Refers to figure 10. From Output LOW, $C_L = 15pF$, Refers to figure 11.		100		ns
			100		ns
Shutdown Timing					
Time to Shutdown, t_{SHDN}	ZT487E	50	200	600	ns
Transmitter Enable from SHUTDOWN to Output HIGH	$C_L = 50pF$, $R_L = 110\Omega$. Refers to figure 5.		200		ns
Transmitter Enable from SHUTDOWN to Output LOW	$C_L = 50pF$, $R_L = 110\Omega$. Refers to figure 6.		200		ns
Receiver Enable from SHUTDOWN to Output HIGH	$C_L = 15pF$, $R_L = 1k\Omega$. Refers to figure 12.		200		ns
Receiver Enable from SHUTDOWN to Output LOW	$C_L = 15pF$, $R_L = 1k\Omega$. Refers to figure 12.		200		ns
Transceiver Throughput					
Maximum Data Rate	$R_L = 54\Omega$, $C_L = 50pF$, $T_A = 25^\circ C$.	0.25			Mbps
ESD Tolerance					
ESD HBM	RS485 Inputs and Outputs		± 15		kV

Pin Description

Pin Numbers			Name	Description
ZT487E/ZT485ER	ZT488ER/ZT490ER	ZT489ER/ZT491ER		
1	2	2	RO	Receiver Output. If A>B by 200mV, then RO = HIGH; If A<B by 200mV, then RO = LOW
2	n/a	3	\overline{RE}	Receiver Output Enable. Low active input. RO is high-Z when \overline{RE} = HIGH
3	n/a	4	DE	Driver Output Enable. The transmitter outputs, Y and Z, are enabled when DE = HIGH. The outputs are high-Z when DE = LOW.
4	3	5	DI	Driver Input. A low on DI forces output Y low and output Z high A high on DI will bring output Y high and output Z low.
5	4	6, 7	GND	Analog Ground
n/a	5	9	Y	Non-inverting transmitter output
n/a	6	10	Z	Inverting transmitter output
6	n/a	n/a	A	Non-inverting transmitter output and non-inverting receiver input.
n/a	8	12	A	Non-inverting receiver input.
7	n/a	n/a	B	Inverting transmitter output and inverting receiver input.
n/a	7	11	B	Inverting receiver input
8	1	14	V _{CC}	Power Supply Input, +5V ±5%
n/a	n/a	1, 8, 13	NC	No Connect, Not internally connected

Circuit Description

The ZT487E, ZT485ER, ZT489ER, ZT490ER, and ZT491ER are low-power transceivers for RS-485 and RS-422 communications. The RS-485 standard is ideal for multi-drop applications and for long-distance interfaces. The TIA/EIA-485 specification allows up to 128 drivers and 128 receivers to be connected to a data bus, making it an ideal choice for multi-drop applications. RS-485 transceivers are equipped with a wide (-7V to +12V) common mode range to accommodate ground potential differences since the cabling can be as long as 4,000 feet. As RS-485 is a differential interface, data is virtually immune to noise in the transmission line.

The ZT487E, ZT488ER, and ZT489ER are slew-rate limited, minimizing EMI and reducing reflections caused by improperly terminated cables.

RS-485 Transmitters

Each device in the ZT4xxER family contains a differential output line transmitter that can drive voltage into multiple loads on a terminated two-wire pair, and a receiver that accepts a differential voltage down to 200mV. The transmitter's differential output can comply with RS-485 and also RS-422 standards. The typical voltage output swing with no load is 0V to V_{CC} . With worst case loading of 54 ohms across the differential outputs, the drivers can maintain greater than 1.5V voltage levels, which is more than adequate for a differential receiver to acknowledge a logic state. The 54 ohms is the equivalent of two 120 ohm termination resistors placed on each side of the transmission line and the input impedance of 128 receivers on the line. The ZT485ER transmitter has an enable control line which is active HIGH. A logic HIGH on DE (pin 3) will enable the differential outputs. A logic LOW on DE (pin 3) will disable the transmitter outputs. While disabled, the transmitter outputs are in high impedance.

RS-485 Receivers

Each transceiver contains one differential receiver that has an input sensitivity of 200mV. The input impedance of the receivers is typically 15 kohms. A wide common mode range of -7V to +12V allows for large ground potential differences between systems.

The ZT485ER, ZT489ER, and ZT491ER receivers have an enable control input. A logic LOW on \overline{RE} will enable the receiver, a logic HIGH on \overline{RE} will disable the receiver. The receivers are equipped with the fail-safe feature, which guarantees that the receiver output will be in a HIGH-IMPEDANCE state when the input is left unconnected.

The ZT485ER, ZT490ER, and ZT491ER can transmit and receive at data rates up to 10Mbps. The ZT487E, ZT488ER, and ZT489ER are specified for data rates up to 250kbps.

Bus Configuration

The ZT489ER, ZT490ER, and ZT491ER are full-duplex transceivers, while the ZT487E and ZT485ER are half-duplex.

For full duplex, the devices are used as a four-wire bus transceiver with a configuration that the transmitters and receivers are moving data independent of each other. Transmit can occur on a dedicated two-wire pair and receive can occur on an adjacent two-wire pair, with each pair transferring data at up to 10Mbps (up to 250kbps for the ZT489ER).

Half duplex is a configuration where the transmitter outputs are connected to its receiver inputs. This application is common for two-wire interfaces where either the transmitter is active or the receiver is active. It is common to connect the enable inputs for the transmitter and receiver together so that a logic HIGH will enable the transmitter and disable the receiver. Conversely, a logic LOW will disable the transmitter and enable the receiver. Half-duplex configurations and these devices are designed for bidirectional data transmission on multipoint twisted-pair cables for applications, such as digital motor controllers, remote sensors and terminals, industrial process control, security stations and environmental control systems.

ESD Immunity

Electro-Static Discharge (ESD) is an important factor when implementing a serial port into a system, especially in harsh environmental conditions. These industrial strength devices provide extra protection against ESD and are intended for harsh environments where high-speed data communication is important.

All of the ZT485ER family of transceivers incorporate internal protection structures on all pins to protect against ESD charges encountered during handling and assembly. The driver outputs and receiver inputs have extra protection against static electricity as they are directly interfacing to the outside environment. As such, these pins against ESD of ± 15 kV without damage in all states of the transceiver's operation in the static state. After multiple ESD events, Zywyn's ZT485ER family of transceivers keep working without latchup. These devices eliminate the need for external transient suppressor diodes and the associated high capacitance loading, allowing reliable high-speed data communications.

The Human Body Model has been the generally accepted ESD testing method for semiconductors. This test is intended to simulate the human body's potential to store electrostatic energy and discharge it to an integrated circuit upon close proximity or contact. This method will test the IC's capability to withstand an ESD transient during normal handling such as in manufacturing areas where the ICs tend to be handled frequently.

Function Table

ZT487E/ZT485ER

DRIVER				RECEIVER		
Input DI	Enable DE	Outputs		Differential Inputs $V_{ID} = V_A - V_B$	Enable \overline{RE}	Output RO
		A	B			
H	H	H	L	$V_{ID} \leq -0.2V$	L	L
L	H	L	H	$-0.2V < V_{ID} < +0.2V$	L	U
X	L	Z	Z	$+0.2V \leq V_{ID}$	L	H
Open	H	H	L	X	H	Z
X	Open	Z	Z	X	Open	Z

ZT488ER/ZT490ER

DRIVER				RECEIVER	
Input DI	Outputs		Differential Inputs $V_{ID} = V_A - V_B$	Output RO	
	Y	Z			
H	H	L	$V_{ID} \leq -0.2V$	L	
L	L	H	$-0.2V < V_{ID} < +0.2V$	U	
X	Z	Z	$+0.2V \leq V_{ID}$	H	
Open	H	L	X	Z	
X	Z	Z	X	Z	

ZT489ER/ZT491ER

DRIVER				RECEIVER		
Input DI	Enable DE	Outputs		Differential Inputs $V_{ID} = V_A - V_B$	Enable \overline{RE}	Output RO
		Y	Z			
H	H	H	L	$V_{ID} \leq -0.2V$	L	L
L	H	L	H	$-0.2V < V_{ID} < +0.2V$	L	U
X	L	Z	Z	$+0.2V \leq V_{ID}$	L	H
Open	H	H	L	X	H	Z
X	Open	Z	Z	X	Open	Z

Note:

H = High Level; L = Low Level; Z = High Impedance; X = Irrelevant; U = Undetermine State.

Pin Configuration

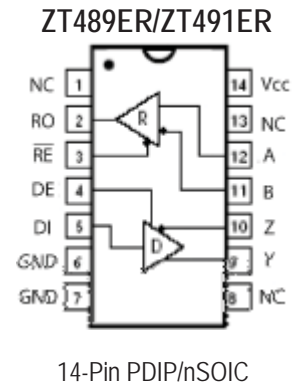
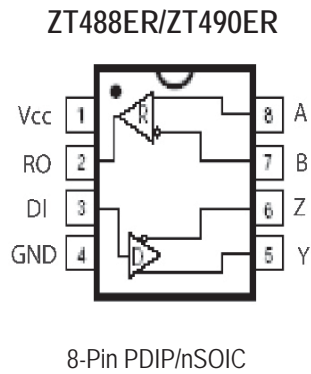
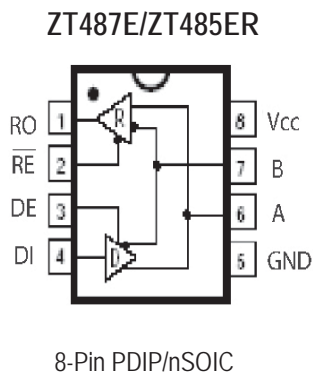

Typical Application Circuits

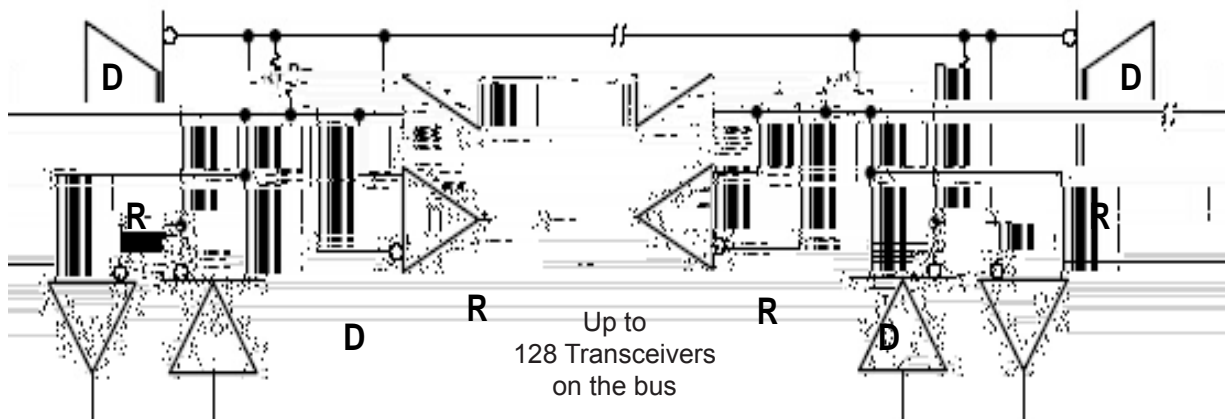

Notes:

- A. The bus should be terminated at both ends in its characteristic impedance of $R_T = Z_0$.
- B. Stub lengths off the main bus should be kept as short as possible.
- C. Can connect up to 128 devices on the same common bus.

Typical Test Circuits

Notes:

- A. The test load capacitance includes probe and test jig capacitance, unless otherwise specified.
- B. The signal generator had the following characteristics:
Pulse rate = 1000 kHz, 50% duty cycle, $Z_0 = 50\Omega$, t_r & $t_f < 6\text{ns}$, unless otherwise specified.

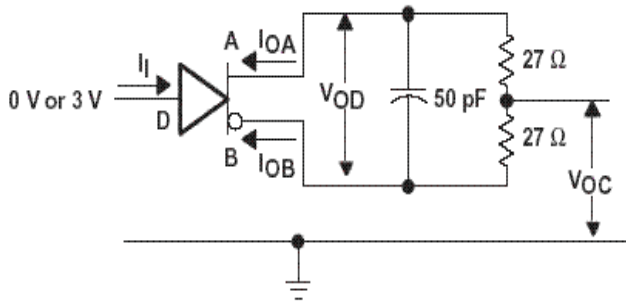

Figure 1. Driver Test Circuit, V_{OD} and V_{OC} Without Common-Mode Loading

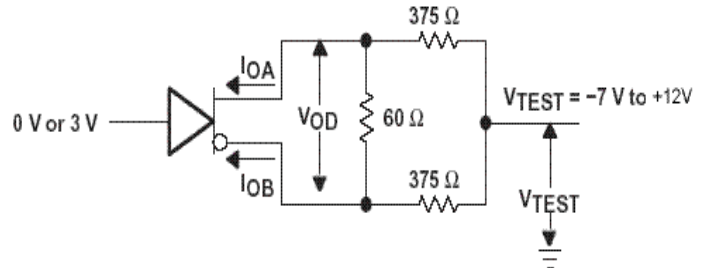

Figure 2. Driver Test Circuit, V_{OD} With Common-Mode Loading

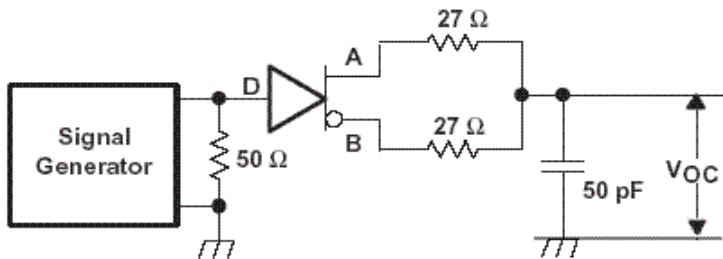

Figure 3. Driver Common-Mode Output Voltage (V_{OC}) Test Circuit and Waveforms

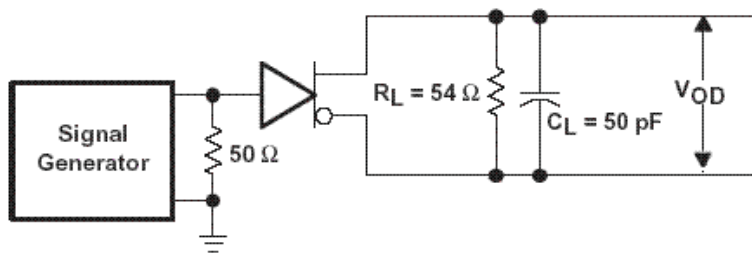
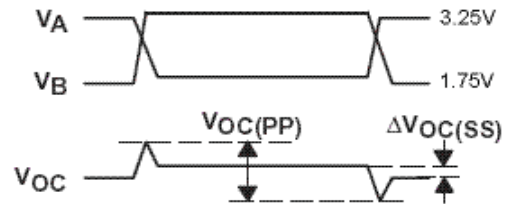

Figure 4. Driver Differential Output Voltage (V_{OD}) Switching Test Circuit and Waveforms

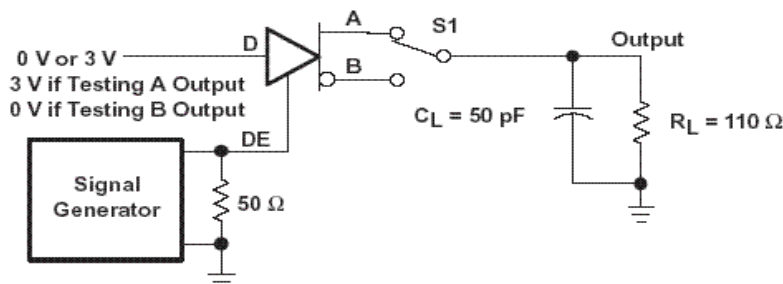
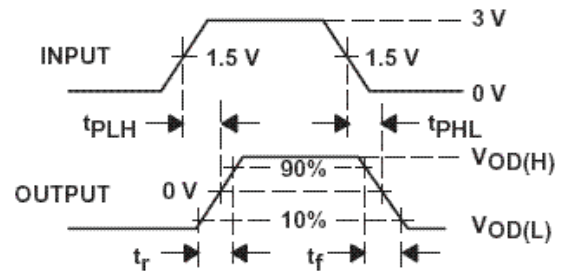
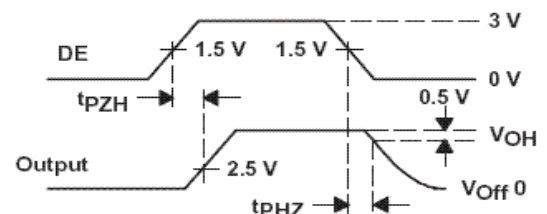

Figure 5. Driver Enable/Disable Test Circuit and Waveforms, High Output



Typical Test Circuits

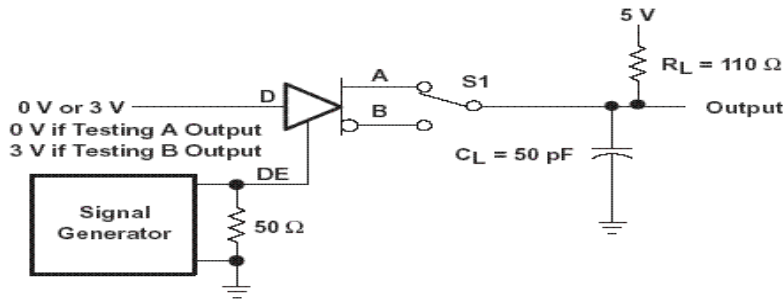

Figure 6. Driver Enable/Disable Test Circuit and Waveforms, Low Output

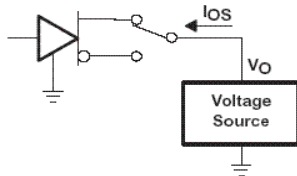

Figure 7. Driver Short-Circuit Test Configuration

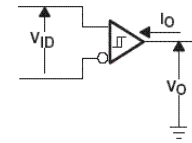

Figure 8. Receiver Parameter Definitions

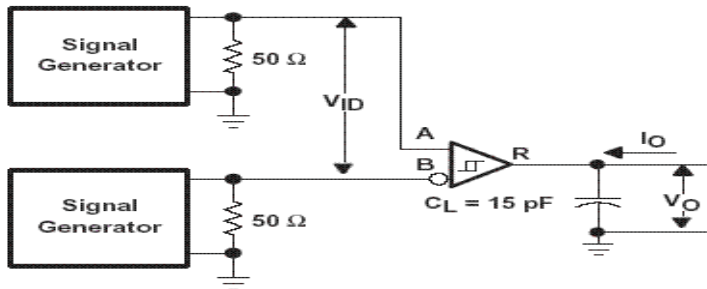

Figure 9. Receiver Propagation (t_{PLH} and t_{PHL}) Test Circuit and Waveforms

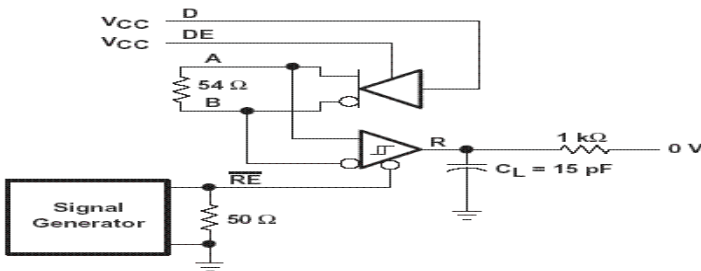
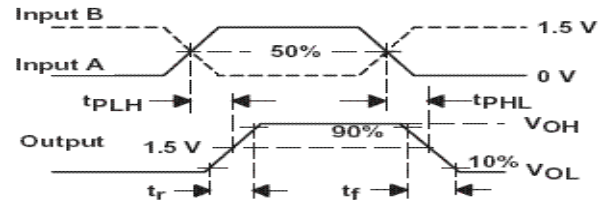

Figure 10. Receiver Output Enable/Disable Test Circuit and Waveforms, Data Output High

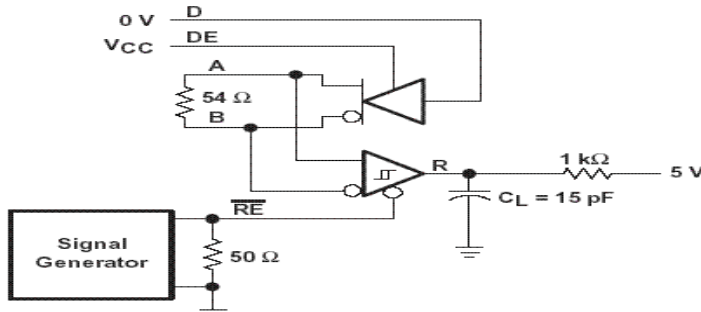
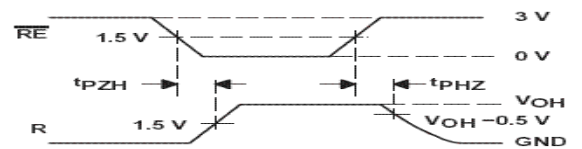
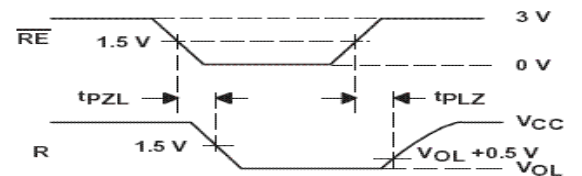

Figure 11. Receiver Output Enable/Disable Test Circuit and Waveforms, Data Output Low



Package Information

SYMBOLS	DIMENSIONS IN MILLIMETERS			DIMENSIONS IN INCHES		
	MIN	NOM	MAX	MIN	NOM	MAX
A	3.6	3.9	4.2	0.142	0.154	0.165
A1	0.38	—	—	0.015	—	—
A2	3.25	3.30	3.45	0.128	0.130	0.136
b	0.38	0.48	0.56	0.015	0.019	0.022
b1	1.48	1.58	1.88	0.058	0.062	0.074
b2	0.813	0.99	1.14	0.032	0.039	0.045
C	0.20	0.25	0.30	0.008	0.010	0.012
D	9.12	9.30	9.53	0.359	0.366	0.375
E	7.62	7.87	8.26	0.300	0.310	0.325
E1	6.20	6.35	6.60	0.244	0.250	0.260
e	—	2.54	—	—	0.100	—
eB	8.38	—	9.40	0.330	—	0.370
L	3.18	—	—	0.125	—	—
S	0.71	0.84	0.87	0.028	0.033	0.038

APPROVED BY		DATE	TITLE :	
DRAW BY:		01/24/00	8L P-DIP PACKAGE OUTLINE	
CHECK BY:			DRAWING FOR MITSUMI	
APPROVAL:			DWG. NO. PO-DIP-019	
APPROVAL:			UNIT :	REV. 0
			INCH	SCALE : 6/1
				SHEET 1 OF 1

CUSTOMER :	ZYWYN CORPORATION
------------	-------------------

TO P

 X : A ~ T
 Y : 0 ~ 9

SYMBOLS	DIMENSIONS IN MILLIMETERS			DIMENSIONS IN INCHES		
	MIN	NOM	MAX	MIN	NOM	MAX
A	1.47	1.60	1.73	0.058	0.063	0.068
A1	0.10	—	0.25	0.004	—	0.010
A2	—	1.45	—	—	0.057	—
b	0.33	0.41	0.51	0.013	0.016	0.020
C	0.19	0.20	0.25	0.0076	0.008	0.009
D	4.80	4.85	4.95	0.189	0.191	0.195
E	5.80	6.00	6.20	0.228	0.236	0.244
E1	3.80	3.90	4.00	0.150	0.154	0.157
e	—	1.27	—	—	0.050	—
L	0.40	—	1.27	0.016	0.028	0.050
y	—	—	0.076	—	—	0.003
φ	0"	—	8"	0"	—	B"

8-pin nSOIC

CUSTOMER:		
APPROVED BY:	DATE:	TITLE:
DRAW BY:		8L NARROW BODY
CHECK BY:		
APPROVAL:		DWG. NO.
APPROVAL:		REV.
UNIT:	INCH	SCALE:
		SHEET 1 OF 1

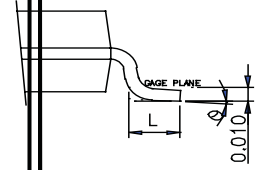
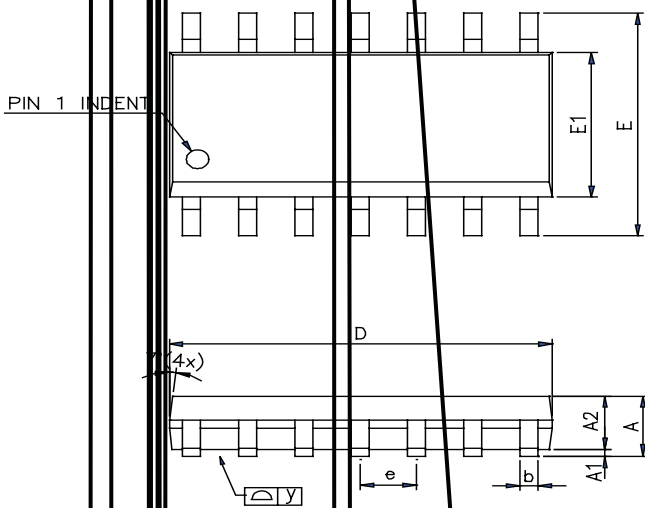

DETAIL A

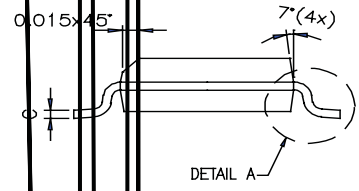

DETAIL A













- NOTE :
1. CONTROLLING DIMENSION : INCH
 2. LEAD FRAME MATERIAL : COPPER 194
 3. DIMENSION "D" DOES NOT INCLUDE MOLD FLASH, TIE BAR BURRS AND GATE BURRS. MOLD FLASH, TIE BAR BURRS AND GATE BURRS SHALL NOT EXCEED 0.006 [0.15mm] PER END. DIMENSION "E1" DOES NOT INCLUDE INTERLEAD FLASH. INTERLEAD FLASH SHALL NOT EXCEED 0.010 [0.25mm] PER SIDE.
 4. DIMENSION "b" DOES NOT INCLUDE DAMBAR PROTRUSION. ALLOWABLE DAMBAR PROTRUSION SHALL BE 0.003 [0.08mm] TOTAL IN EXCESS OF THE "b" DIMENSION AT MAXIMUM MATERIAL CONDITION. DAMBAR CANNOT BE LOCATED ON THE LEAD RADIUS OR THE FOOT. MINIMUM SPACE BETWEEN PROTRUSION AND AN ADJACENT LEAD TO BE 0.0028 [0.07mm]
 5. TOLERANCE : ±0.010 [0.25mm] UNLESS OTHERWISE SPECIFIED.
 6. OTHERWISE DIMENSION FOLLOW ACCEPTABLE SPEC.
 7. REFERENCE DOCUMENT : JETEC SPEC MS-012

SYMBOLS	DIMENSIONS IN INCHES		
	MIN	NOM	MAX
	0.058	0.063	0.068
	0.004	—	0.010
	—	0.057	—
	0.013	0.016	0.020
	0.0075	0.008	0.008
	0.189	0.191	0.195
	0.228	0.236	0.244
	0.150	0.154	0.157
	—	0.050	—
	0.016	0.028	0.050
	—	—	—
	0"	—	B"

14-pin nSOIC

CUSTOMER:		
ZYWYN CORPORATION		
APPROVED BY:	DATE:	TITLE:
DRAW BY:		14L NARROW BODY SMALL
CHECK BY:		OUTLINE PACKAGE DRAWING
APPROVAL:		DWG. NO. PO-SOP-002
APPROVAL:		REV. 1
UNIT:	INCH	SCALE: 12/1
		SHEET 1 OF 1

Ordering Information

Part Number	Temperature Range	Package Type	Green Package	MOQ/Tube	MOQ/T&R
ZT487LEEN	-40°C to +85°C	8-pin nSOIC		100	2500
ZT487LEEP	-40°C to +85°C	8-pin PDIP		60	N/A
ZT485LEREN	-40°C to +85°C	8-pin nSOIC		100	2500
ZT485LEREP	-40°C to +85°C	8-pin PDIP		60	N/A
ZT488LEREN	-40°C to +85°C	8-pin nSOIC		100	2500
ZT488LEREP	-40°C to +85°C	8-pin PDIP		60	N/A
ZT489LEREN	-40°C to +85°C	14-pin nSOIC		58	2500
ZT489LEREP	-40°C to +85°C	14-pin PDIP		30	N/A
ZT490LEREN	-40°C to +85°C	8-pin nSOIC		100	2500
ZT490LEREP	-40°C to +85°C	8-pin PDIP		60	N/A
ZT491LEREN	-40°C to +85°C	14-pin nSOIC		58	2500
ZT491LEREP	-40°C to +85°C	14-pin PDIP		30	N/A

Please contact the factory for pricing and availability on Tape-and-Reel options.

Zywyn Corporation

Headquarters and Sales Office

1270 Oakmead Parkway, Suite 201 • Sunnyvale, CA 94085 • Tel: (408) 733-3225 • Fax: (408) 733-3206

Email: sales@zywyn.com • www.zywyn.com

Zywyn Corporation reserves the right to make changes to any products described herein. Zywyn does not assume any liability arising out of the application or use of any product or circuit described herein; neither does it convey any license under its patent rights nor the rights of others.

© 2010 Zywyn Corporation